

PARTNER/TEAM K12FD FIRE/RESCUE SAW

Designed exclusively for the fire service, pound-per-pound this saw is the most effective power cutter in the field. It features a modified Fire Department 95cc Partner K950 Active - 2-cycle gas engine - includes: constant "Ready Start" ignition switch, large D handle starter grip, chrome blade guard w/welded D rings for attaching saw sling, saw carrying sling, fire department reflective lettering, wrench & instruction manual. Weight is only 27 lbs.



Ordering Information

Part No.	Description
K-12FD	Fire department rescue saw, 14" chrome blade guard, w/o blade and case

Saw Kits

K-12FD Mega Kit

MEGA12FD-F	Kit contains, K-12FD 14" rescue saw, full size diamond plate aluminum case, 1 DYNA-II carbide chip blade, 4 rescue abrasive wheels, safety gas can, hearing protector, goggles, spare drive belt and air filter, air filter oil, 2-cycle oil and gas stabilizer.
MEGA12FD-SSA	Same as above kit but with space saver diamond plate aluminum case

K-12FD Super Mega II Kit

K12FDSUPERMEGAIIF	Kit contains, K-12FD 14" rescue saw, full size diamond plate aluminum case, 2 PIRAYA diamond blades, 1 DYNA-II carbide chip blade, 2 LIGHTNING diamond blades, 2 rescue abrasive wheels, safety gas can, hearing protector, goggles, spare drive belt and air filter, air filter oil, 2-cycle oil and gasoline stabilizer.
K12FDSUPERMEGAIIF-SSA	Same as above kit with space saver diamond plate aluminum case

Replacement Blades and Wheels Ordering Information

Part No.	Description	Part No.	Description
Diamond Blades - Best All Around Quality Blade		Carbide Blades	
TD12MP	12" x 1" USAR/FEMA diamond blade*	DYNA-12A	12" x 1" carbide "chip" Dyna-II
TD14MP	14" x 1" USAR/FEMA diamond blade*	DYNA-14A	14" x 1" carbide "chip" Dyna-II
* Use on masonry material		700216FD	12" x 1" 16 tooth fire dept. carbide tipped ventilation blade
TD12SC	12" x 1" TORNADO diamond blade**	700118FD	14" x 1" 18 tooth fire dept. carbide tipped ventilation blade
TD14SC	14" x 1" TORNADO diamond blade**	Abrasive Wheels	
** Use on metal material		T1210	12" x 1" rescue abrasive wheel (steel & concrete)
PIRA-12FD	12" X 1" PIRAYA diamond cut-all-blade ***	T1410	14" x 1" rescue abrasive wheel (steel & concrete)
PIRA-14FD	14" X 1" PIRAYA diamond cut-all-blade ***	375156	12" x 1" steel abrasive wheel
*** Use on concrete, metal, wood		375200	14" x 1" steel abrasive wheel
TLDB12	12" x 1" LIGHTNING diamond blade ****	375157	12" x 1" concrete abrasive wheel
TLDB14	14" x 1" LIGHTNING diamond blade ****	375201	14" x 1" concrete abrasive wheel
**** Use on both steel and concrete			
**** Use on wood, concrete, steel, plastic, glass & more			

CALL
800.833.0247
281.479.9700

FAX
800.282.4365
281.479.6321

CALL US TODAY

-161-

www.safetyfire.com

VentMaster™ X-Torque Ventilation Saw

The New Husqvarna Pro 575XT is the most advanced power head available for fire service operation. With higher peak power and 20% more torque, the 575XT provides maximum cutting power over a longer range while improving productivity. The new One Step Starting, which combines the choke, throttle lock and stop mechanism all in one switch, eliminates flooding and allows fast convenient starting. The Raptor Carbide tipped chain was engineered to withstand the rigors of fire service operation. The Raptor cuts quicker and lasts longer than bullet chain or single raker carbide chain.

The 575XT Rescue Ventilation Saw has a unique “One Step” Ignition/Choke/Fast Idle Switch which eliminate flooding and allows for quick engine start and stops.



Depth Gauge

Ordering Information

Part No. Description

- TV-400-051 Model 575XT-16-DG saw with depth gauge, 16” bar and .404 pitch chain
- TV-400-050 Model 575XT-20-DG saw with depth gauge, 20” bar and .404 pitch chain

Also available are saws w/o depth gauge and saws with .375 pitch chain.

VentMaster™ Cutoff Saws

Features

- **Fast, Easy Starting:** A compression release button reduces the amount of force required to get the saw started. A D-ring starter handle makes the saw easy to crank while wearing heavy gloves.
- **Versatility for Tough Cutting Jobs:** A 180° reversible cutting arm allows cutting within one inch of walls, curbs, or vertical obstructions. Ideal for tight confined space situations that require awkward cutting angles.



Model 375K

Specifications

	375K	3120K
Power:	75cc	120cc
Disc Sizes:	14”	14-16”
Sound Level:	102dB	103dB
Weight:	21.2 lbs.	30.9 lbs.



Model 3120K

Ordering Information

Part No. Description

- TV406-500 Model 375K-DG cutoff saw, w/depth gauge, less blade
- TV406-510 Model 3120K-DG cutoff saw, w/depth gauge, less blade
- TV406-001 Model 375K cutoff saw, w/o depth gauge, less blade
- TV406-013 Model 3120K cutoff saw, w/o depth gauge, less blade

Ordering Information - Saw Blades

- | Part No. | Description |
|-----------------|------------------------------|
| TV406-002 | Multi-cut blade, 14” |
| TV406-003 | Abrasive-masonry blade, 14” |
| TV406-009 | Abrasive-metal blade, 14” |
| TV406-074 | Diamond multi-use blade, 14” |

SV3 Ventilation Saw

Combining rugged construction, smooth performance and raw power, the lightweight SV3 Power Pro ventilation saw is the solution for your rescue saw needs. With a powerful Dolmar 6.3 hp engine that turns at 13,500 rpm, your department can rely on the Super Vac SV3 for venting and rescue operations. With a full-wrap handle designed for maximum versatility, this saw tackles a variety of operations with ease, including cutting through residential roofing, removing downed trees, and ripping through various building materials. With a quick start compression release and “always on” ignition, the SV3 is ready to go when you are. Comes complete with a full cover/depth gauge and a carbide chisel chain.



Ordering Information

Part No.	Description
SV3-16	Ventilation saw with 16” bar and depth gauge
SV3-20	Ventilation saw with 20” bar and depth gauge

SVC3 Cutoff Saw

Rescue operations demand fast reliable cutting equipment. The SVC3 Power Pro Cutoff saw is designed for the high performance required by the fire and rescue service. Its rugged, lightweight Dolmar power head turns an industrial diamond blade that’s voracious enough to cut through a variety of materials including residential and corrugated roofing, concrete, rebar, sheet metal, and steel and aluminum - all without the use of water. Features include a multi-position cutting arm, a blade safety shield that adjusts without having to fumble with hard-to-grasp knobs, a D-ring pull handle, and a manual compression release for quick starts. A water tube dust suppression is standard.



Comes standard with a 14” Tiger Tooth diamond blade. This hi-tech diamond blade eliminates the need to carry different blades for different materials. The new electroplated core technology in the blade allows the Tiger Tooth to outlast and outperform other blades on the market.

Ordering Information

Part No.	Description
SVC3-14	Cut-off saw with 14” Tiger Tooth diamond blade
SVC3-14-KIT-AL	Cut-off saw with 14” Tiger Tooth diamond blade, and tread plate aluminum carrying case
SVC3-14-KIT-ST	Cut-off saw with 14” Tiger Tooth diamond blade and steel carrying case
SVC310-14	14” Tiger Tooth diamond blade

Axes

Ordering Information

Part No.	Description
10-97015	Pick head axe with 6-lb. head and 36" hickory handle
10-97016	Pick head axe with 6-lb. head and 36" yellow fiberglass handle
10-97017	Flat head axe with 6-lb. head and 36" hickory handle
10-97018	Flat head axe with 6-lb. head and 36" yellow fiberglass handle
10-97049	Flat head force axe with 8-lb. head and 36" yellow fiberglass handle w/rubber grip
WPL-4	Pulaski axe with 3.75-lb. head and 36" wooden handle
10-97046	Vinyl pick protector for pick head axe, color red (not shown)

Pick Head Axe



Flat Head Axe



Force Axe



Pulaski Axe



Axe Blade Brackets

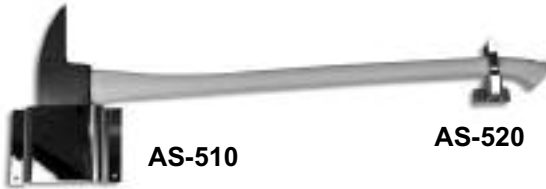

AS-510

AS-520

Ordering Information

Part No.	Description
AS-510	Axe blade bracket for horizontal mounting, polished aluminum
AS-520	Axe handle bracket, chrome plated zinc

Sledge Hammers

Drop forged high carbon steel heads, heat treated, machined faces, fiberglass handle.



Ordering Information

Part No.	Description
FSY-8	8-lb. sledge hammer, with 36" fiberglass handle
FSY-10	10-lb. sledge hammer, with 36" fiberglass handle
FSY-12	12-lb. sledge hammer, with 36" fiberglass handle
FSY-16	16-lb. sledge hammer, with 36" fiberglass handle

Pry Bars

Drop forged high grade steel, heat treated, with pinch point

Ordering Information

Part No.	Description
PPB-36	6-lb. 36" pry bar
PPB-48	10-lb. 48" pry bar
PPB-60	18-lb. 60" pry bar
PPB-66	26-lb. 66" pry bar
10-97027	2-pc. Spring loaded holding bracket for pry bar, chrome plated (not shown)

Spencer's Truckman®

The Truckman® Is A Tool That Does All This & More

- Easily pierces and removes wall and ceiling materials (sheet rock and plaster lathe)
- Chips, pries, gouges, tears, and acts as a lever
- Removes trim, window, and door jams
- Removes and cuts through roofing, siding materials and metal sheeting
- Handle - 100,000 volts dielectric stability & 10,000 lbs. plus breaking strength
- Nail puller
- Pry bar
- Gas shut off capability
- Chopping and scoring ability

Features

Head: Polished stainless steel

Handle: Yellow fiberglass with curved polypropylene jacket

Handle length: 19-1/2"

Weight: under 3 lbs.



Ordering Information

Part No. Description

10-97148	Truckman® axe, without scabbard
10-97149	Axe scabbard with nylon belt

T-N-T Tool (Formerly The Denver Tool)

The TNT TOOL gives you the use of five tools in one: an axe, sledge hammer, pry tool, ram, and D-handle pull tool. No other large hand tool gives you the versatility to chop, pry, pull, strike, beat, and reach. The TNT TOOL will open 95% of doors. It is completely made in the U.S.A. Cast with high carbon heat treated steel and finished with a baked on yellow powder coat paint and a solid fiberglass handle. Five sizes to choose from. Comes with a lifetime warranty - fixed free if broken under normal use.



Ordering Information

Part No. Description

TN840	8-1/2 lb. head, 40" long, weight 13-1/2 lbs.
TN835	8-1/2 lb. head, 35" long, weight 13 lbs.
TN640	6-1/2 lb. head, 40" long, weight 12 lbs.
TN635	6-1/2 lb. head, 35" long, weight 11-1/2 lbs.
TN630	6-1/2 lb. head, 30" long, weight 11 lbs.
TNBRC	Aluminum mounting bracket with a rubber hold down strap (2/set)

Handle Color Available in Either Yellow (Y) or Black (B).



Channellock 6 in 1 Rescue Tool

6 in 1 Rescue Tool - steel punch to shatter safety glass, shut off for gas safety valves, spanner wrench to tighten and loosen hose couplings, pry bar for opening windows and doors, laser-treated edges to cut cables, cross-hatch teeth that twist and pull.

Features

- Weighs 1.62 lbs.
- Length 10.46"

Ordering Information

Part No.	Description
88	6 in 1 rescue tool

CALL
800.833.0247
281.479.9700

FAX
800.282.4365
281.479.6321

CALL US TODAY

-165-

www.safetyfire.com

Hooligan Tools

The Paratech Hooligan Tool has set the standard of excellence for Halligan type tools. Now available with a machined alloy shaft for lighter weight, these heavy-duty tools were designed to pry, pound, puncture, twist, and cut open or remove all types of barriers between emergency service personnel and saving a life.

Features

- A gently curved claw maximizes prying leverage
- Parallel claw opening fits over locks, hasps and many door bars
- Double as a nail puller and gas shut off tool
- Aluminum Alloy Shaft (22-000424 and 22-000430)

Ordering Information

Part No.	Description	Weight (lbs.)
Standard Claw with Electroless Nickel Finish		
22-000599	24" long	10.0
22-000600	30" long	11.4
22-000601	36" long	12.7
22-000602	42" long	14.2

Metal Cutting Claw with Electroless Nickel Finish

22-000622	30" long	11.4
22-000623	36" long	12.7
22-000624	42" long	14.2

Standard Claw with Lightweight Aluminum Handle with Electroless Nickel Finish

22-000424	24" long	7.32
22-000430	30" long	7.78

Standard Claw with Tactical Black Finish

22-000670	30" long	11.4
22-000671	36" long	12.7

Spark Resistant, made from AMPCOLY 45 Standard Claw

22-891600	30" long	11.2
-----------	----------	------

Metal Cutting Claw

22-891622	30" long	11.2
-----------	----------	------

Accessories

22-000605	Mounting brackets, 2/set
22-000842	Carrying strap and clamp assembly

**Standard Claw with Electroless Nickel Finish
No. 22-000600**



**Metal Cutting Claw with Electroless Nickel Finish
No. 22-000622**



**Standard Claw with Tactical Black Finish
No. 22-000670**



**Spark Resistant made from AMPCOLY 45 Standard Claw
No. 22-891600**



Hook and Claw Tool

A heavy duty prying tool designed for overhauling. Usually found on Ladder (Truck) Companies, the Claw Tool is very practical for prying floorboards, baseboards, window casements and door frames.

The Hook, has a 6.5" opening and is machine sharpened. The claw is parallel slotted with a recessed nail puller to remove locks, hasps and shut gas valves. The entire tool is electroless nickel plated for ease of maintenance and appearance.

Ordering Information

Part No.	Description	Weight (lbs.)
22-000590	30" long	11.7
22-000591	36" long	13.0
22-000592	42" long	14.3



Kelly Tool (West Coast Tool)

The Kelly Tool is an excellent tool for anyone who wants a hooligan tool without the protruding spike. It is often used in a wedge & sledge combination with a flat head axe. The working features include a claw for prying, a nail puller, and adz for chopping, and a striking surface for accepting or delivering hammer blows.

Ordering Information

Part No.	Description	Weight (lbs.)
22-000560	30" long	11.8
22-000561	36" long	13.1
22-000562	42" long	14.5



Buster Tool

Compact, versatile and rugged the Buster Tool is the perfect compact forcible entry tool. It features an axe blade for cutting, chopping and busting and a specially designed "H" section pike for penetration. The molded neoprene handle is ergonomically shaped and has a grip enhancing surface. Available with a compact positive grip prying claw with a nail pulling feature and claw locking lever for two-position claw placement.

Manufactured from Alloy 17-4 PH hardened stainless steel the compact Buster has an extended length of 21.5 inches and a closed length of 15.5 inches.

Ordering Information

Part No.	Description	Weight (lbs.)
22-000300	Buster with compact claw	5.2
22-000301	Buster with standard claw	5.2
22-000505	Sheath For Buster Tool	0.5
22-000330	Tactical holster for Buster Tool	1.0

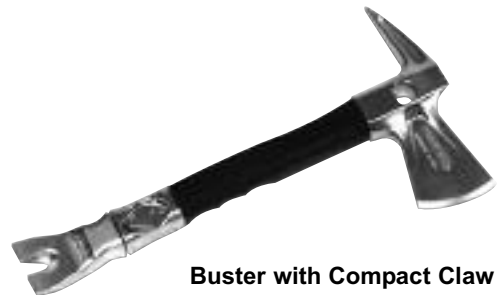

Buster with Compact Claw

Pry Axe

Widely used for over forty years by fire departments, police departments and rescue squads worldwide. The Pry Axe is a lightweight, multi-purpose, slam and ram tool designed to pry, enlarge openings, cut sheet metal and twist off locks and latches.

The Pry Axe head and claw assemblies are separate sections forged from high alloy steel and heat treated for maximum strength. A solid steel shaft is press fitted and pinned to the claw. A tubular steel handle is press fitted and welded to the head.

A rubber sleeve over the handle provides a non-slip grip. The Pry Axe is chrome plated for good looks and easy maintenance. It is 28 inches extended and 18 inches closed.

Ordering Information

Part No.	Description	Weight (lbs.)
22-000522	Pry Axe with metal cutting claw	6.6
22-000520	Pry Axe with standard claw	6.6
22-000515	Pry Axe with standard claw and sheath	7.0
22-000505	Sheath for Pry Axe	0.5



Tools

Biel Tool

The Biel Tool, (pronounced BEE'L) is a personal size multi-purpose forcible entry and rescue tool, designed for forcing doors and windows, prying and twisting hasps and locks, light overhauling, metal cutting and chopping.

The Biel Tool, incorporates many features as the "Pry Axe", but is small, 15 inches long in its closed position and 19" inches extended and is light enough to wear on a belt, or to carry in the pocket of a bunker coat. It is constructed of alloy steel forgings, heat treated for maximum strength and durability, and chrome plated for easy maintenance.

Ordering Information

Part No.	Description	Weight (lbs.)
22-000550	Biel Tool	3.2
22-000551	Biel Tool with sheath	3.7
22-000555	Sheath for Biel Tool	0.5



The PRT is the ultimate emergency service penetrating tool. The slam and ram feature utilizes over 13 inches of stroke which allows you to deliver the same force as a sledge hammer but with pinpoint accuracy. By eliminating the dangerous backswing arc of a hammer blow, two (2) things happen.

1. There is no hammer deflection. All of the striking power is delivered to the point of impact.
2. Safety is greatly improved over a wide range of the PRT kit also includes seven (7) interchangeable bits that can easily be changed depending on your current obstacle. With the correct tool bit the PRT can penetrate concrete masonry, sheet metal and many composite materials. An optional penetrating nozzle is also available for extinguishing engine compartment fires, mobile home fires, aircraft fires, and more.

The kit rolls into a self contained pouch weighing only 29 pounds allowing the PRT to be carried to the task.

Ordering Information

Part No.	Description	Length
22-000625	PRT complete rescue kit	31.5"



PRT Complete Rescue Kit

Kit Components

22-000627	PRT bar only	29.5"
22-098107	Chisel - 3" wide	18.3"
22-098101	Bullpoint - 14" long	16.0"
22-098111	Chisel - 1" wide	16.0"
22-000636	Lock breaker claw	10.5"
22-000637	Metal cutting claw	12.6"
22-015472	Carrying pouch	32.6"



Wide Chisel Tip



Metal Cutting Claw

Optional Penetrator Bit for Water or Foam

22-098106	6" Penetrator	17.6"
22-098114	14" Penetrator	27.3"



Bullpoint



1" Chisel Tip

Quick Connector for Penetrator Bits

22-550320	1-1/2" NH	3.1"
-----------	-----------	------



Lock Breaker Claw

Super Ram Bar

The Super Ram Bar uses the "Slam & Ram" power stroke made famous by Paratech. Just place the drop forged lockbreaker claw where you want the force applied and "Slam & Ram". No more dangerous backswings in crowded hallways. All the force is delivered where and when you want it.

Ordering Information

Part No.	Description	Weight (lbs.)
22-500560	33" long	16



Hydra-Ram The Ultimate In Forcible Entry

The first and only one piece integrated hydraulic forcible entry tool. No hoses or auxiliary pumps to leak or trip on.

Features

- 10,000 lbs. of force is presented at 138 lbs. of pumping to acquire 3/4" opening per stroke to maximum thrust opening of 4 inches. 6 inches with Hydra-Ram II
- Can be placed in any position even upside down without any effect on its operation
- A patented process incorporating integral aircraft seals of triplex quality is used to prevent leaking fluid
- Hydraulic fluid is non-flammable, non-toxic and non-freezing
- Special stainless steel of 220,000 tensile strength make-up the jaws
- Body is special aluminum heat treated and hard anodized to a darkened color of tactical black
- Special finger grips are attached for a non-slip holding surface
- The entire unit can be controlled by one user alone making it truly a one-person operation tool



No. 10-97038

Ordering Information

Part No.	Description
10-97038	Hydra-Ram with 4" thrust opening
10-97039	Hydra-Ram II with 6" thrust opening

- Included with unit: a heavy Cordura® bag, carrying strap and 1 lb. rubber mallet
- Weighs only 12 lbs.
- Length 13 inches

Tools



No. 10-97040



No. 10-97044



No. 10-97047 No. 10-97048

Pro-Bar

- Forcible entry bar made of dropped forged aircraft steel. Standard color gunmetal gray, black (B) and silver (S) colors available
- Fork, adz and point are designed with correct lengths and widths to allow easy penetration and leverage
- Roof pro-bar comes with two rings and a heavy duty shoulder strap
- Jumbo pro-bar comes with ring on bottom part for roof/vent operations

Ordering Information

Part No.	Description
10-97040	30" pro-bar
10-97041	30" roof pro-bar
10-97042	54" jumbo pro-bar
10-97043	12" mini pro-bar
10-97044	16" mini pro-bar
10-97045	20" mini pro-bar
10-97047	Pro-bar flat mount brackets, chrome plated (2/set)
10-97048	Pro-bar side mount brackets, chrome plated (2/set)

Dynamic Trio - Three Piece Irons Set

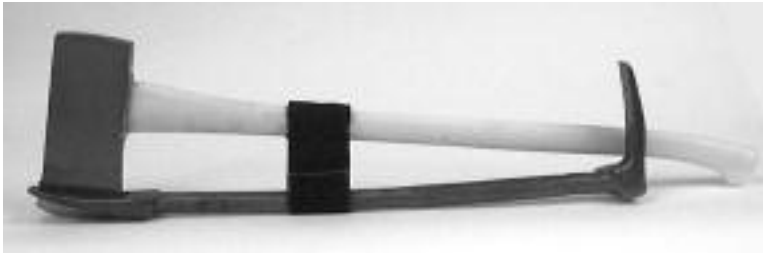

Part No.	Description
10-97050	Three piece forcible entry tool set consisting of: No. 10-97049 8-lb. force axe No. 10-97040 30" pro-bar No. 10-97052 marrying strap

Dynamic Foursome - Four Piece Irons Set

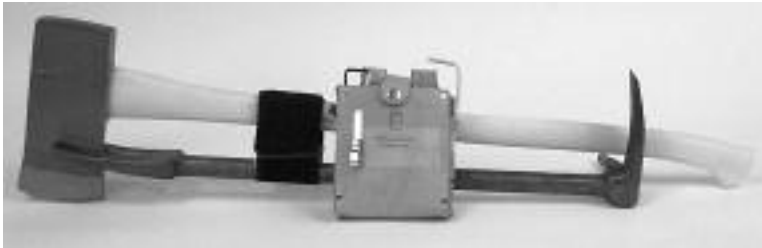

Ordering Information

Part No.	Description
10-97051	Four piece forcible entry tool set consisting of: No. 10-97049 8-lb. force axe No. 10-97040 30" pro-bar No. 10-97052 marrying strap No. 10-97008 K-Tool kit

Marrying Strap

The Marrying Strap is designed to marry the Pro-Bar and the axe for ease in carrying. It allows the fire fighter to have one hand free to hold the ladder rung, stair railing or flashlight. Also called the "Irons".

Ordering Information

Part No.	Description
10-97052	Marrying strap

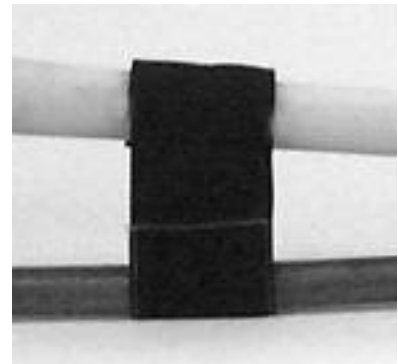

Heavy Duty Bolt Cutters

Bolt Cutters are heavy duty contractor type cutters with rugged extended nose straps that support the cutting edge reducing chipping and prevents cutting above the cutters rated capacity. Cutters feature sanded celtex handle grips eliminating hand shock after cutting.

Capabilities Include:

Cutting concrete reinforcing rods, soft and medium hard bolts, rivets, bars and chains.

Non-Conductive Heavy Duty Bolt Cutters- have yellow fiberglass handles with celtex grips. The fiberglass handles will withstand 25,000 volts per inch.*

***Note: This is not a guarantee. Always be extra careful around electricity and take appropriate measures before working with electricity.**



Ordering Information

Part No. Description

10-97055	Bolt cutter, 18" length, 5/16" capacity
10-97056	Bolt cutter, 24" length, 3/8" capacity
10-97057	Bolt cutter, 30" length, 7/16" capacity
10-97058	Bolt cutter, 36" length, 1/2" capacity

Non-Conductive Heavy Duty Bolt Cutters

NCBC-18	18" length, 5/16" capacity
NCBC-24	24" length, 3/8" capacity
NCBC-30	30" length, 7/16" capacity
10-97059	36" length, 1/2" capacity

Barracuda Rescue Saw

The Barracuda is an excellent tool for cutting auto windshields, mobile homes, aircraft skin, cutting and chopping ice, 18 wheeler roof trailers, wood and sheet metal. Has a honed two angle penetrating point, 10 two-sided cross cutting teeth, celtex covered upright handle and a "D" handle at rear for positive control.



Ordering Information

Part. No. Description

10-97060	Barracuda rescue saw
----------	----------------------

Glas-Master Tool

The Glas-Master is a unique tool that can remove glass in less than a minute reducing rescue time significantly. It is to be used by one person and requires no electricity or hydraulics. Cuts on pull stroke thereby pulling glass to the outside, away from the victim. It can also be used on wood, fiberglass and plaster. Has "T" handle, front guard, blade w/ cover and window punch that can be safely stowed when not in use.



Ordering Information

Part No. Description

10-97061	Glas-Master tool
GMM-B46	Replacement blade, 4-6 tpi

O-Tool Kit (Officers Tool)



Designed for through-the-lock method of forcible entry. The O-Tool removes the lock cylinder and the Kerry Key slides or turns the lock mechanism to the unlocked position. All steel construction, welded and forged. "A" type adz at one end and pry chisel at the other end. Overall length is 17-1/2". Kit includes: a Kerry Key, Shove Knife with protective sleeve and shock absorbing sanded non-slip Celtex grip.



Kerry Key

Ordering Information

Part No.	Description
10-97004	O-Tool kit complete
10-97005	O-Tool only, without key, knife and celtex grip (weight: 1-1/2 lbs.)
10-97006	Kerry Key only

Shove Knife



The Shove Knife is the fastest, most damage free means of opening residential and office interior doors with "key in the knob" locks. Works from either side of door. If Door opens inward, you shove the knife in back of the molding stop and retract the latch, For doors that open towards you, the knife is slipped in from above the latch point and jiggled and pulled to retract the latch. Protective sleeve is provided when not in use.

Ordering Information

Part No.	Description
10-97007	Shove knife

K-Tool Kit



The K-Tool is designed to pull all types of cylinders from the various glass type or solid doors. The K-Tool is driven over the protruding edge of the lock cylinder and

then pried off with a Hooligan Tool or other standard tool of leverage. A loop on the tool can receive the adz end or fork end of the forcible entry tool. Once the lock cylinder is pulled from the door then the key tools are used to operate the mechanism. Complete K-Tool kit includes: K-Tool, Shove Knife, two lock tool keys, leather carrying pouch and instruction on through-the-lock method.

Ordering Information

Part No.	Description
10-97008	K-Tool kit complete
10-97009	Replacement blades (2/set)
10-97010	Replacement tool keys (2/set)
10-97010A	Replacement leather pouch

R-Tool Kit

The R-Tool is designed to pull all types of lock cylinders too big for the K-Tool. The kit consists of: R-Tool, carrying bag, set of lock tool keys and a Shove Knife.

Ordering Information

Part No.	Description
10-97011	R-Tool kit complete

Hockey Puck Lock Breaker



Designed to break the strongest locks like flush locks found on rolled-up doors in commercial buildings and on the rear doors of trucks. Handle has sanded celtex grip. Weight 12 lbs. Length: 40"

Ordering Information

Part No.	Description
10-97012	Hockey puck lock puller



Ultra-Lite Pike Pole

The “ULTRA-LITE” pike poles are made of 1-1/4” hollow round shaped, yellow fiberglass creating a heavy duty pike pole that is light weight and designed to handle comfortably. The “ULTRA-LITE” rod uses a continuous strand of fiberglass matte with unidirectional roving fiberglass to give it maximum strength. The fiberglass poles will not rust, corrode or dry rot. They are tough, durable, electrically resistant and like all fiberglass products require no maintenance.

Gripper Pipe Poles (PP)

The “Gripper” pike poles are made of solid elliptial shaped (3/4” x 1-1/8”), yellow fiberglass rod creating a heavy duty pike pole that is designed to handle comfortably, even while wearing gloves. All “Gripper” pike poles are fitted with non-slip, black rubber hand grips. The fiberglass poles will not rust, corrode or dry rot. They are tough, durable, electrically resistance and like all fiberglass products require no maintenance.

I-Beam Pike Pole

The “I-BEAM” pike pole has the same heavy duty construction that you have been accustomed to over the years. It is shaped like a massive “I-BEAM” yet slightly rounded to fit your hand and is constructed from a one piece pulltrusion of solid fiberglass. All of our heads are designed to fit perfectly over the “I-BEAM” rod and are held solidly in place with two spring steel roll pins. No epoxy is required to hold the pike pole head in place. Along one edge of the pole is a thumb groove so that you always know the direction of the hook on the end of the pole. The opposite end of each “I-BEAM” pike pole is fitted with a heavy duty rubber bumper so the fiberglass rod does not fray or split.

Tools

Ordering Information - Safety Yellow Fiberglass

Ultra-Lite Part No.	Gripper Part No.	I-Beam Part No.	Description
UL-3	PP-3	IB-3	3 ft. long with standard USA hook
UL-3D	PP-3D	IB-3D	3 ft. long with standard USA hook and “D”- Handle
UL-4	PP-4	IB-4	4 ft. long with standard USA hook
UL-4D	PP-4D	IB-4D	4 ft. long with standard USA hook and “D”- Handle
UL-5	PP-5	IB-5	5 ft. long with standard USA hook
UL-6	PP-6	IB-6	6 ft. long with standard USA hook
UL-8	PP-8	IB-8	8 ft. long with standard USA hook
UL-10	PP-10	IB-10	10 ft. long with standard USA hook
UL-12	PP-12	IB-12	12 ft. long with standard USA hook
UL-14	PP-14	IB-14	14 ft. long with standard USA hook
UL-16	PP-16	IB-16	16 ft. long with standard USA hook

Note: Add to part number for hook other than standard USA style: Dry Wall Hook - DWH, Rubbish Hook - RH, D-Handle - DH



USA Hook Standard



Dry Wall Hook



Rubbish Hook



D - Handle

All-Purpose Hook - Pike Pole

The most versatile hook used in the fire service today. Featuring a multitude of uses, from opening ceilings, walls, floors, moldings and castings to the rapid removal of wood, plaster, lathe, tin, sheet metal, plasterboard, fiberboard and sheetrock. Poles without a "D" handle have a gas shut-off, ram knob and directional slot at the end. Made of solid 1" fiberglass with sanded Celtex Grip.



Gas Shut-Off, Ram Knob and Directional Slot



D Handle



Ordering Information

Part No.	Description
10-97113	32" long w/ "D" handle
10-97114	40" long w/ "D" handle
10-97115	48" long w/ "D" handle
10-97116	4 ft. long
10-97117	5 ft. long
10-97118	6 ft. long
10-97119	8 ft. long
10-97120	10 ft. long
10-97121	12 ft. long
10-97122	14 ft. long

"D" handles available on all models

Pike Poles Brackets 2-Pc Chromed Sets

Ordering Information

Part No.	Description
10-97126	Flat mount bracket set
10-97127	Side mount bracket set

National Hook - Pike Pole

Featuring

- **Pike Head** - Made of tough malleable iron for reliable head strength
- **Pole** - Choice of wood (white ash) or fiberglass. All fiberglass models are made by drawing a 1-1/4" fiberglass tube over rods of ash giving the strongest pole available
- **No Slip Grip** - On fiberglass models the sanded celtex grip is drawn over the fiberglass for positive grip
- **Assembly** - All hooks are completed by using epoxy resins, bonding all parts into one unit

Ordering Information

Wood (White Ash) w/o Celtex Grip

Part No.	Description
10-97062	32" long w/D handle
10-97063	40" long w/D handle
10-97064	4 ft. long
10-97065	5 ft. long
10-97066	6 ft. long
10-97067	8 ft. long
10-97068	10 ft. long

Fiberglass w/ Celtex Grip

Part No.	Description
10-97080	32" long w/D handle
10-97081	40" long w/D handle
10-97082	48" long w/D handle
10-97083	4 ft. long
10-97084	5 ft. long
10-97085	6 ft. long
10-97086	8 ft. long
10-97088	10 ft. long
10-97089	12 ft. long
10-97090	14 ft. long

"D" handles available on all models





Handlelok No. 1004

An adjustable bracket that provides secure mounting for tools, axe handles, poles and other equipment. Heavy-duty locking strap, grip range 1/8" to 1-3/4".

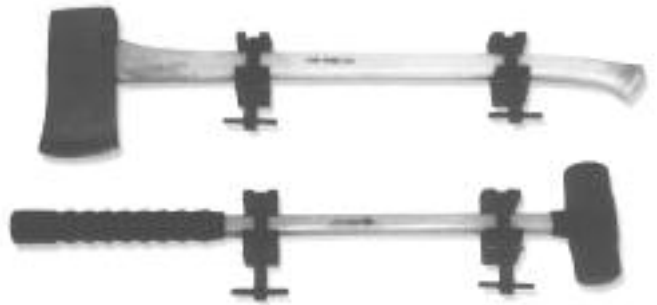

Tools



Toolok No. 1003

Features easy, fast locking and instant release. Black body yellow elastomer locking strap tool mount, grip range 1/8" to 1-1/2".



Hookloks No. 1001

Clamp-action/mounting brackets that depend on automatic clamping force and hook action to restrain tools. Grip range 1" to 1-1/2". Two (2) per set.



Ironslok No. K5003

Protects from sharp points. Mounts "set of irons" in safe, dependable horizontal or vertical position.

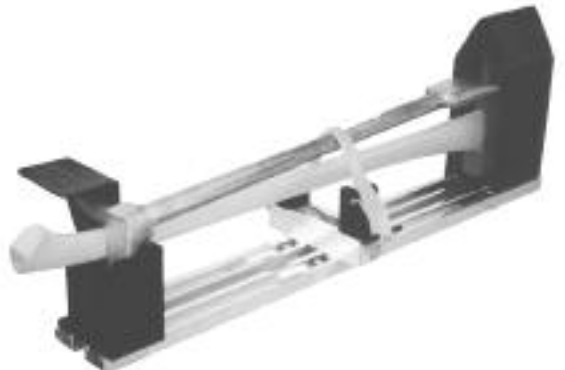



Universal Hanger

No. 1019

Can be used in pairs to mount sledge hammers, picks, etc. Made of rugged polypropylene for strength and corrosion-resistance. Great for chains, cables etc.



Flexmount

No.1002

Space age, high strength, non-metallic, grip-type mount for poles, nozzles and tools.

Grip range 1-3/4" to 2-1/2"



Hanger/Pockets

Nos. 1011 & 1010

Molded high-strength impact and corrosion resistant urethane. Mount the tool head on top (HANGER) or on the bottom (POCKET). Use in conjunction with Handlelok No. 1004

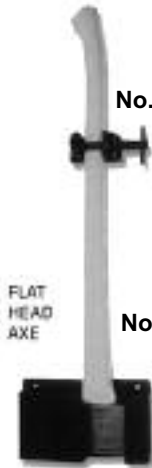

No. 1004



No. 1004

No. 1010

Tool Hanger

No. 1009

Rugged, molded two-prong bracket for simple mounting of "T" head equipment. Use in conjunction with Handlelock No. 1004



No. 1009

No. 1004

Adjustamount Kit

No. K1006

The Adjustamount is the most versatile mounting system ever produced. Adjustamount modules can be custom-positioned on Unistrut to hold nozzles, folding ladders, hydraulic rescue tools, and much more. Includes adjustable Lockstrap (18" overall length, 15" usable length) and a 9" length of Channel Cushion that can be custom-cut to the length required. This cushion provides insulation and a firm bottom grip between the mounted object and the Unistrut. Note: Unistrut is only included in Adjustamount Kits.



No. 1006



No. K5006



Ordering Information

Part No.	Description
1006	Adjustamount, less Unistrut
K5006	Adjustamount kit, with No. 1006 and 12" length of Unistrut, pre-punched for mounting
K5008	Adjustamount kit, with No. 1006 and 24" length of Unistrut, pre-punched for mounting.

Versatile Drip Torch is used for firing semi-dry fuels. It is an ideal tool for prescribed burning, back firing, roadside burning, slash and brush disposal.

The Torch incorporates a ball check valve and fuel trap to prevent flash-backs.

Constructed from 15 gauge seamless aluminum with a rugged forged aluminum bottom to prevent wear and punctures. The spout is reversible for storage. A breathing tube with a shut-off prevents fuel leaks when in the storage mode. Parts are interchangeable with most other drip torches.

Specifications

Height: 14" closed, 25" assembled

Diameter: 6"

Weight: Empty 5 lbs., full 16 lbs.

Capacity: 1 1/4 US Gallons

Meets USDA Spec 5100-614 Jan. 10 2008

UN/D.O.T. approved



Drip Torch stored in Truck Mount Bracket

Ordering Information

Part No.	Description
12000	Dip torch
12001	Truck mounting bracket

McLeod Tool

This tool has proven to be one of the most effective for building fire lines. The hoe blade is effective in cutting through heavy grasses, deep litter and matted brush. The non-clogging rake tines can be used in pine needles, duff and leaf mold. This is an extremely rugged tool. Meets USFS Spec. No. 5100-353.

The McLeod Tool is 48-1/2" long, head is 9" x 9-3/4". Weight 4-3/4 lbs.

Part No. Description

40251	McLeod tool
40252	Replacement handle



Mower Blade Tool

This fire tool has four sharp mower blade teeth that quickly cut through small roots and matted grass. The tool can be used to cut through compact fuels or for light trenching. With duff or pine needles it serves as a rake. Meets USFS Spec. No. 5100-284. Overall length is 52". Weight 3-1/2 lbs.

Part No. Description

40255	Mower Blade Tool
40256	Replacement Handle
40257	Replacement Head



Hoe-Shovel

This tool has a removable pin that allows the shovel to become a hoe. Good for grubbing, digging and general brush clearance.

Part No. Description

40280	Hoe-shovel
-------	------------



Nupla® Shovels

Round and square point shovels are No. 2 hollow back with rolled step. Blade size: Round Point (8-1/2" x 12"), Square Point (9" x 12"), Scoop (15-1/4" x 19-3/4"). Blades are heat treated to aid in resisting wear and breakage. Large scoop shovel is ideal for digging and scooping gravel and other coarse material. Fiberglass handles provide unsurpassed life, comfort, and safety.

Ordering Information

Part No.	Description
69-048	Round point shovel with 48" straight handle
69-027	Round point shovel with 27" "D" - grip handle
69-148	Square point shovel with 48" straight handle
69-127	Square point shovel with 27" "D" - grip handle
69-014	Scoop shovel with 27" "D" - grip handle



Fire Rake

General purpose tool for raking fire lines, digging, rolling burning logs, chopping small brush, weeding and cleaning. Four tempered steel blades are securely riveted in place on an angle iron frame.

Ordering Information

Part No.	Description
10-97207	Fire rake with 60" fiberglass handle



Fire Beater

Used for smothering grass, straw or small brush fire. Fire resistant flap and fiberglass handle.

Ordering Information

Part No.	Description
10-97208	Fire Beater with 60" handle



Fire Broom

Ordering Information

Part No.	Description
FB-42	Fire broom especially adapted for fighting fires, constructed of rattan, with 60" ash handle



Nupla® Squeegee

Ordering Information

Part No.	Description
10-97211	Classic squeegee, 36" wide, 66" handle
10-97212	Replacement edge for squeegee



Non-Sparking, Rust and Corrosion Resistant Safety Tools

Working in hazardous environments is dangerous enough. So don't take unnecessary chances with inferior tools that may not be safe or strong enough to get the job done. TEAM non-sparking safety tool kits provide excellent protection where hazardous materials such as flammable solvents, fuels, gases and explosive powders are present. They are excellent for use around battery acids and other common corrosive media. Manufactured in the USA, the safety tools are approved by FM and meet OSHA requirements for non-sparking use. When life is at stake, team up with top quality, top performance safety tool kits from TEAM.

TAK-31 Deluxe Multi-Purpose Kit

Kit consists of one of each:

Description	Size
Bar, wrecking	23"
Chisel	7/8" x 9"
Drift pin	1/2" x 6"
Hammer, claw	1-1/4 lb.
Knife, common	3-1/8" blade
Knife, putty	2" x 4" blade
Mallet	4 lbs.
Pliers, combination	8"
Pliers, groove joint	2-1/8" capacity
Pliers, side cutting	8"
Pliers, long nose side cutting	7"
Scraper & pry bar	12", 2" blades
Screwdriver, std.	3" blade
Screwdriver, std.	6" blade
Screwdriver, std.	8" blade
Screwdriver, Phillips	#1
Screwdriver, Phillips	#2
Screwdriver, Phillips	#3
Wrench, adjustable end	15/16" capacity
Wrench, adjustable end	1-15/16" capacity
Wrench, box & open end	3/8"
Wrench, box & open end	7/16"
Wrench, box & open end	1/2"
Wrench, box & open end	9/16"
Wrench, box & open end	5/8"
Wrench, box & open end	11/16"
Wrench, box & open end	3/4"
Wrench, box & open end	7/8"
Wrench, bung	(multi-opening)
Wrench, pipe	1-1/2" capacity
Carrying case	26" L x 11-1/2" W x 9-1/2" H



No. TAK-31

TAK-18 Standard Multi-Purpose Kit

Kit consists of one of each:

Description	Size
Bar, wrecking	18"
Hammer, claw	1-1/4 lb.
Knife, common	3-1/8" blade
Knife, putty	2" x 4" blade
Pliers, combination	8" w/cutter
Pliers, groove joint 12"	2-1/8" capacity
Pliers, side cutting	8"
Scraper & pry bar	12", 2" blade
Screwdriver, std.	6" blade
Screwdriver, Phillips	#2
Wrench, adjustable end	8" length, cap. 15/16"
Wrench, box	5/16" x 3/8"
Wrench, box	7/16" x 1/2"
Wrench, box	9/16" x 5/8"
Wrench, box	11/16" x 25/32"
Wrench, box	3/4" x 7/8"
Wrench, pipe	14", 1-1/2" capacity
Carrying case	20" L x 91-1/2" W x 8-1/2" H



No. TAK-18